

Pyramids

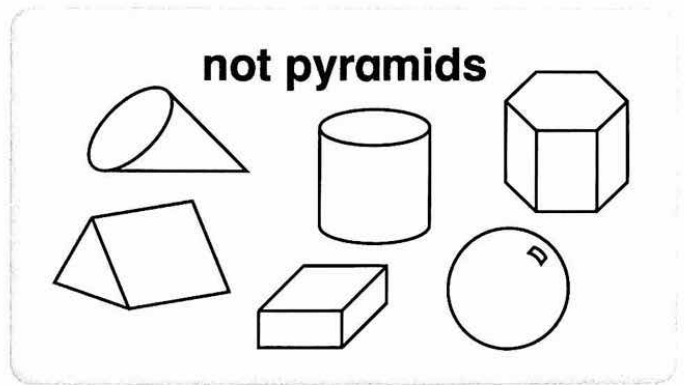

Circle the pyramids.

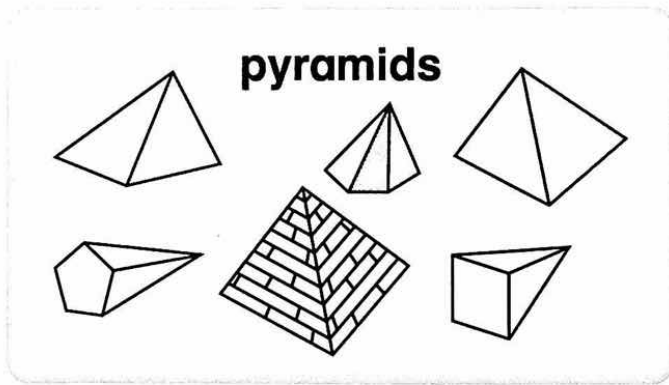
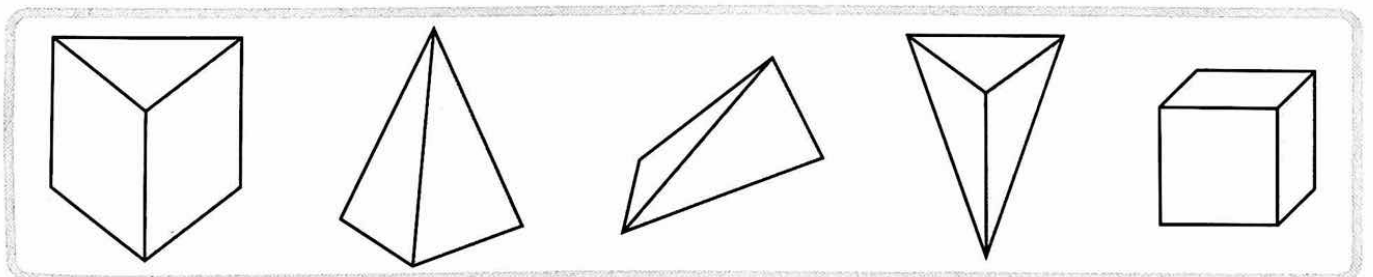
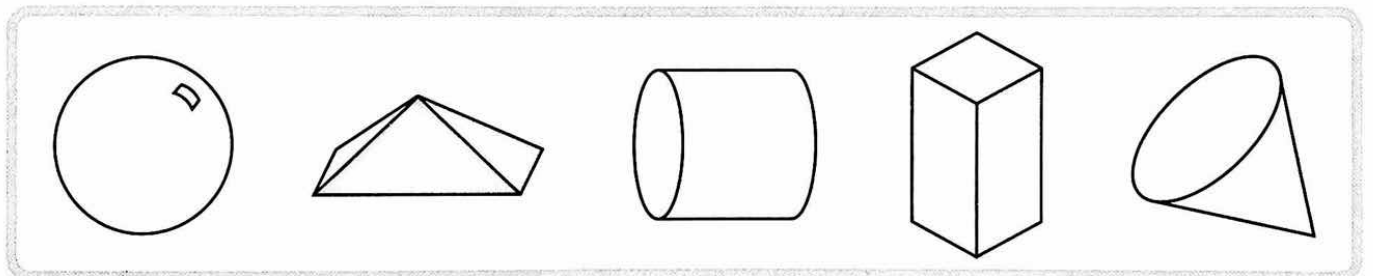
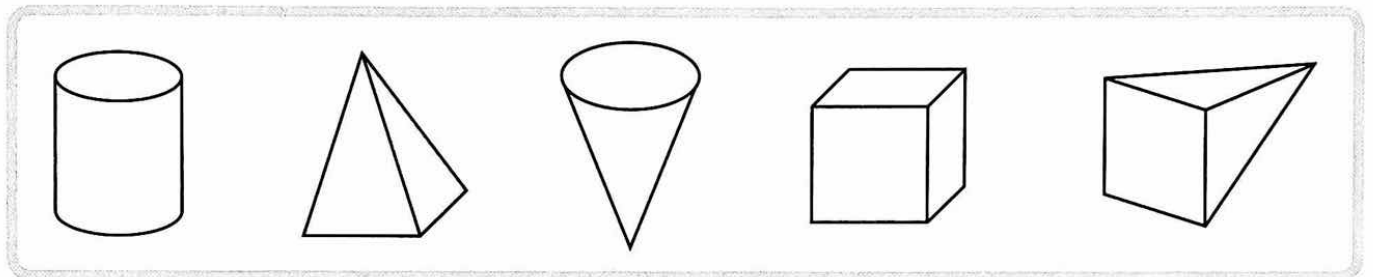

Colour the pyramids in the pictures.

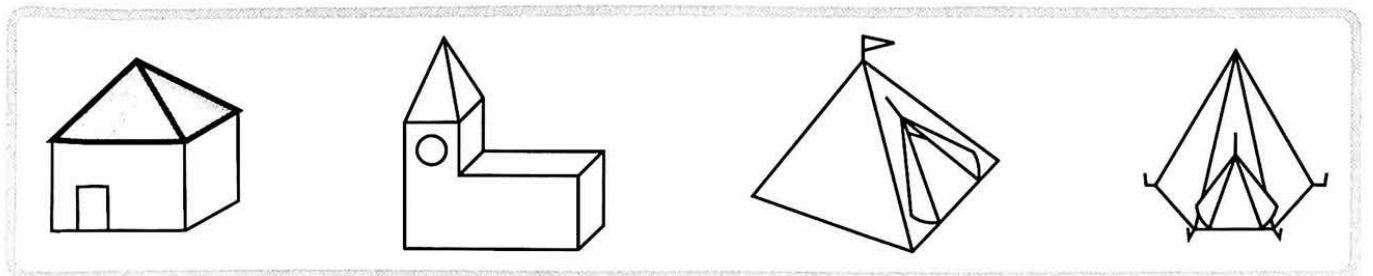

Prisms

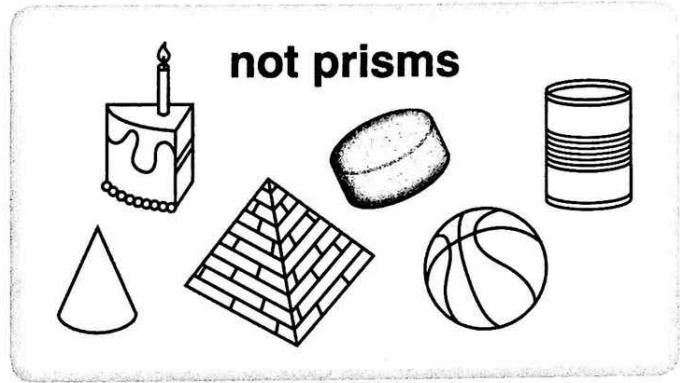
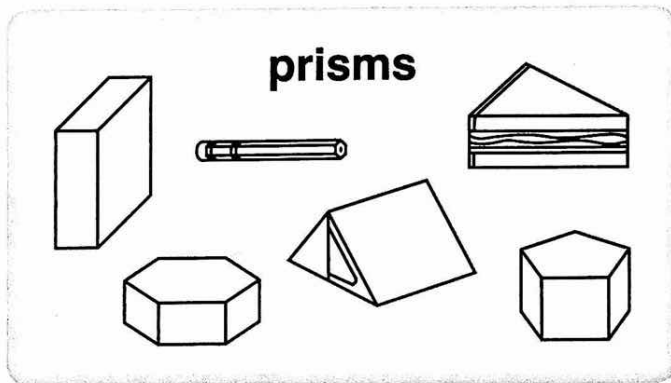

Circle the prisms.

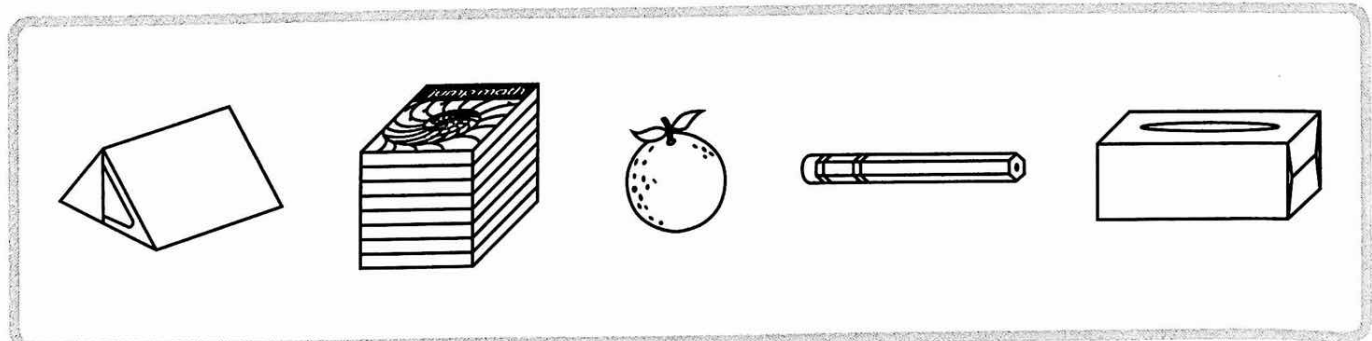
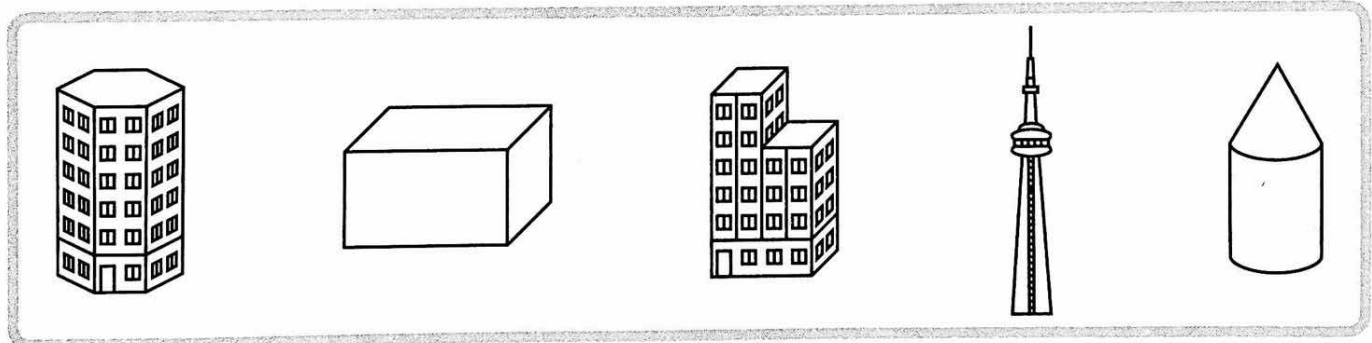
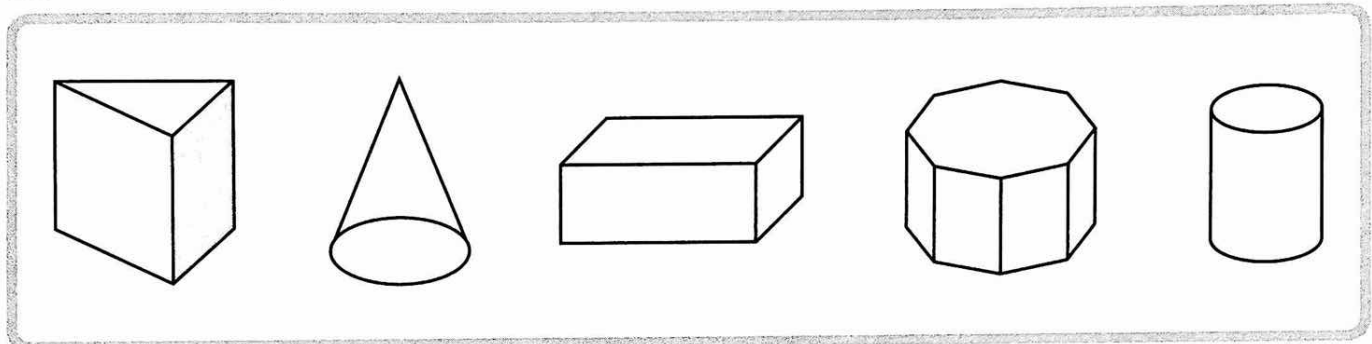

Optional:

Find 2 pictures of objects like a  that are almost prisms. Glue them into your .

Turning 3-D Shapes

Was the object **changed** or **turned**?

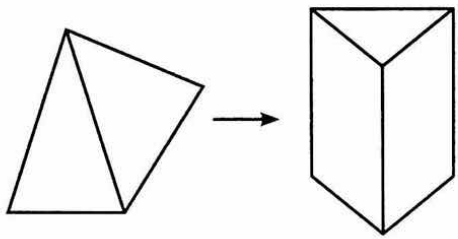

changed

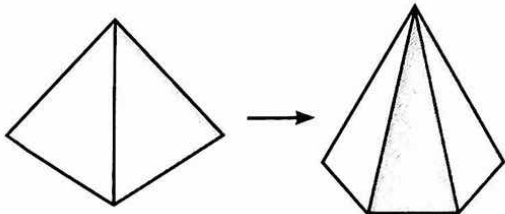
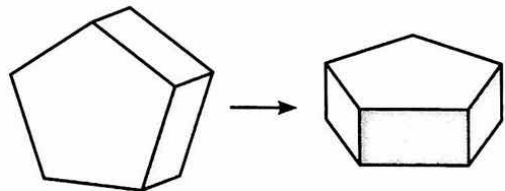
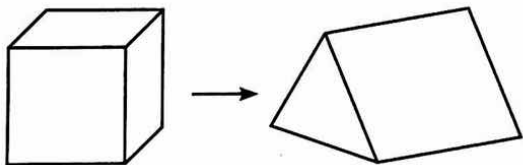
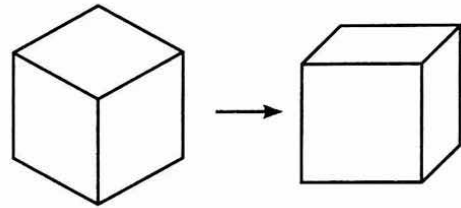
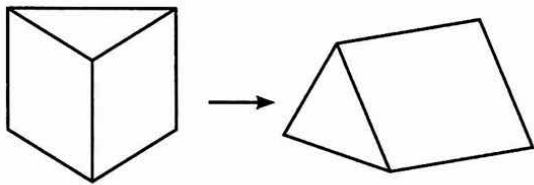
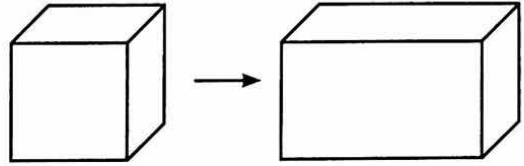

Bonus

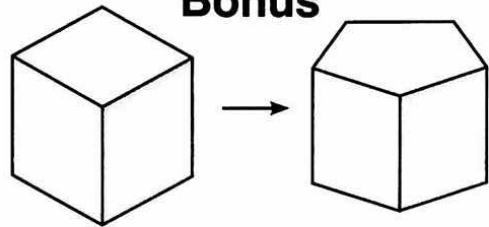

Centimetres

A small  is 1 centimetre long.

Write how many centimetres long.

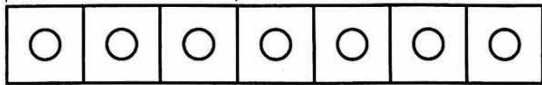
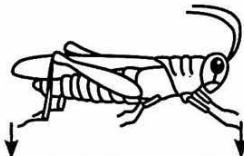

3 centimetres long

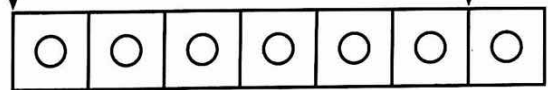
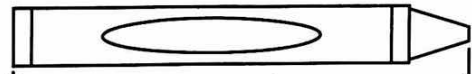

6 centimetres long

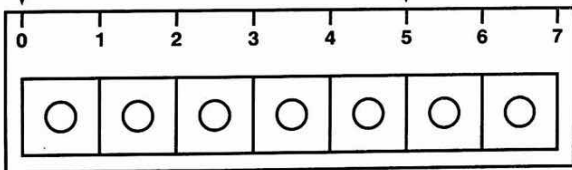
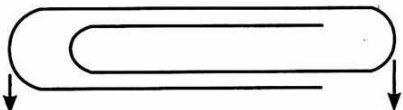

5 centimetres long

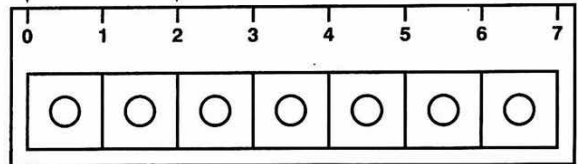
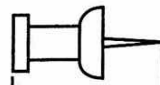

2 centimetres long

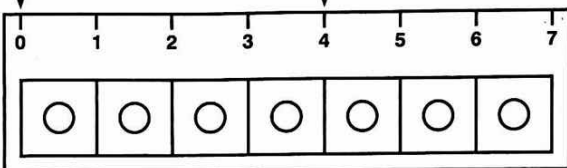

4 centimetres long

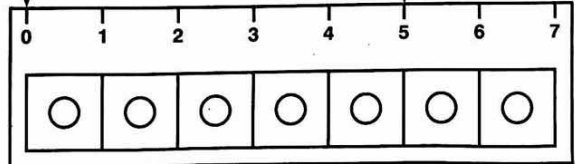

5 centimetres long

We write **cm** for **centimetre**.

Fill in the blanks.

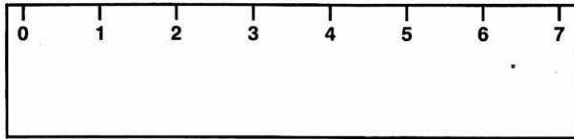

___ cm wide

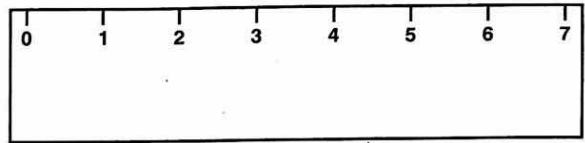

___ cm wide

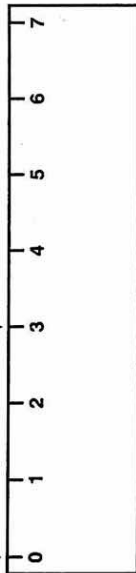
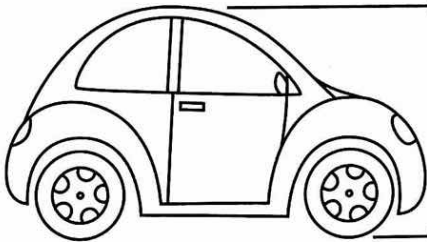

___ cm tall



___ cm tall

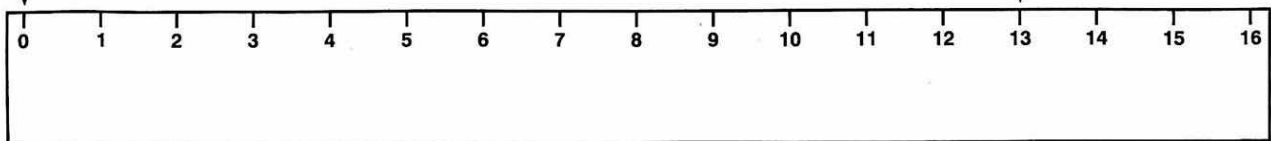
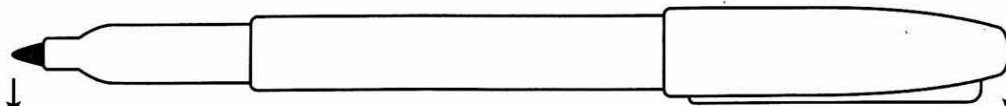

___ cm long

Comparing Masses

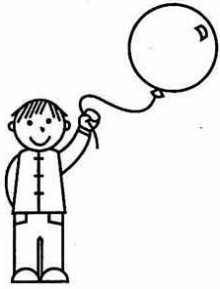

A  is **lighter** than a .

A  is **heavier** than a .

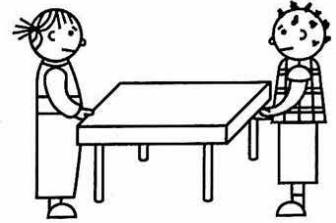

Circle the one that is **lighter**.

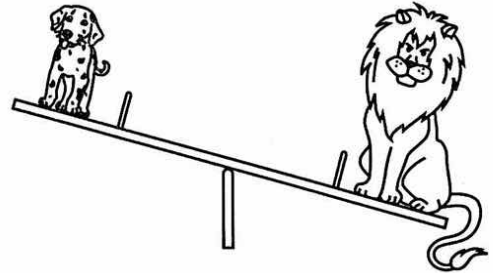
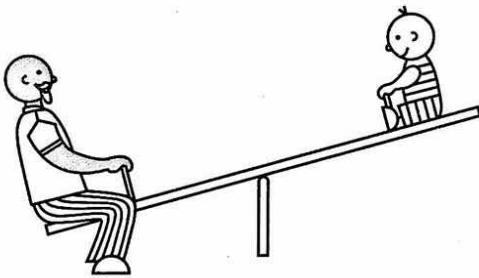
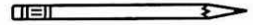
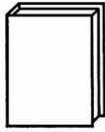

Circle the one that is **heavier**.

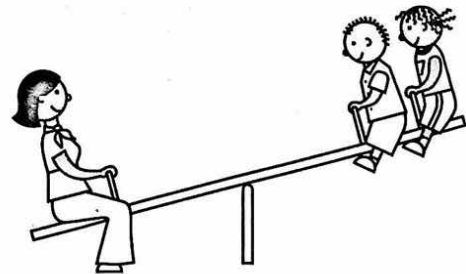
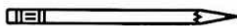

What is **heavier** than ? What is **lighter** than ?

Measuring Capacity

Circle the container that holds **more**.

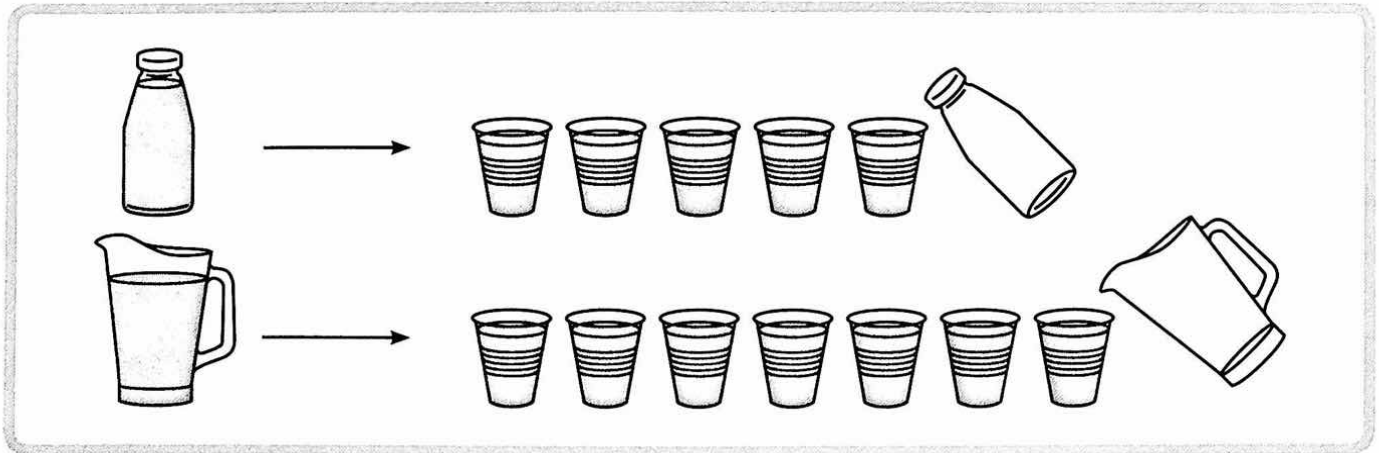

Circle the container that holds **less**.

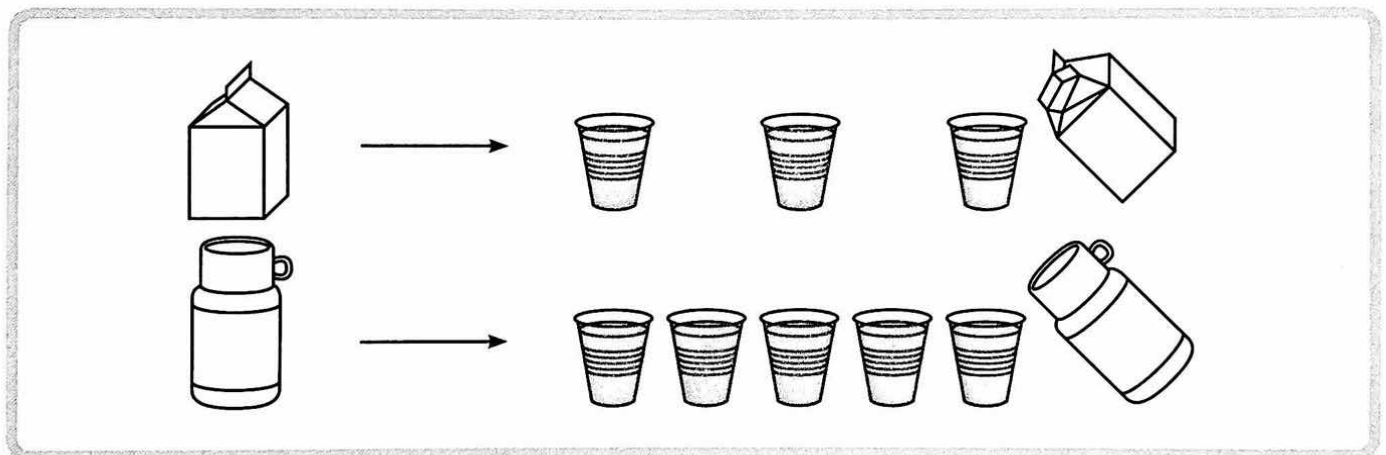

Order the containers from largest (1st) to smallest (3rd).

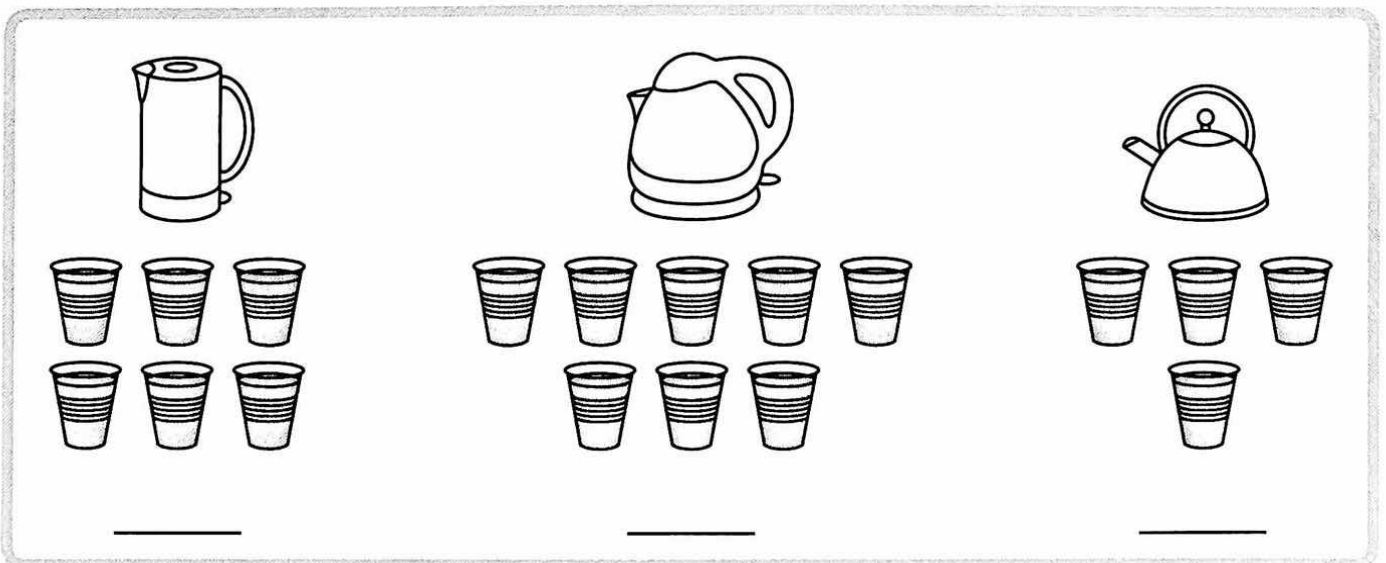

Measuring Cups

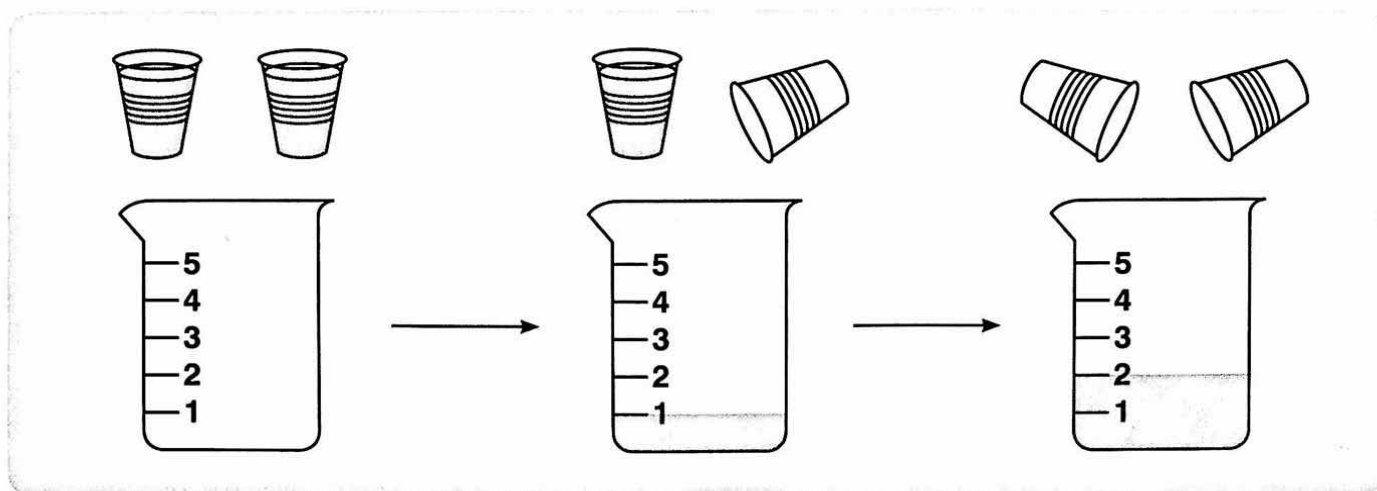

How much water?

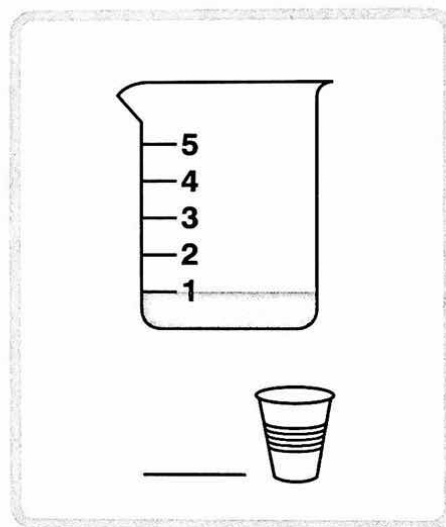
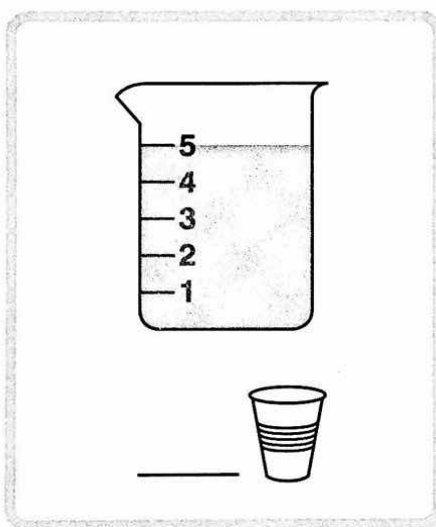
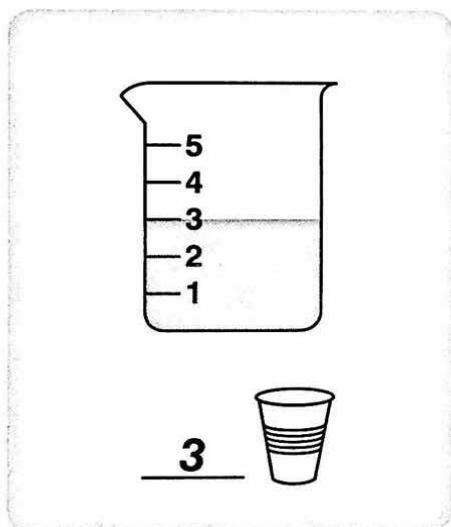

About how much water?

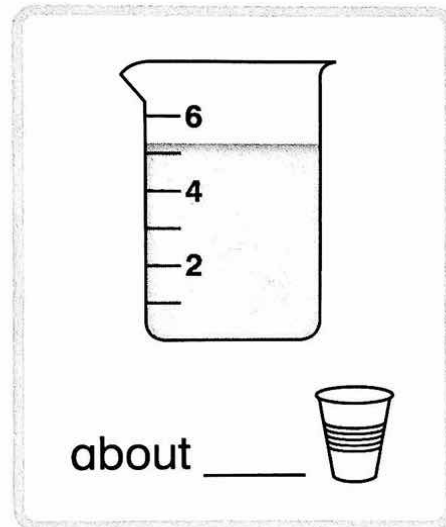
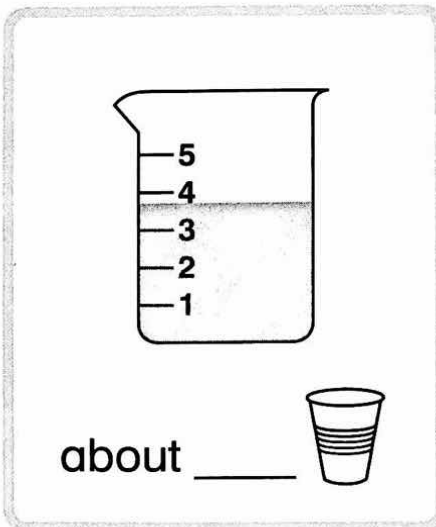
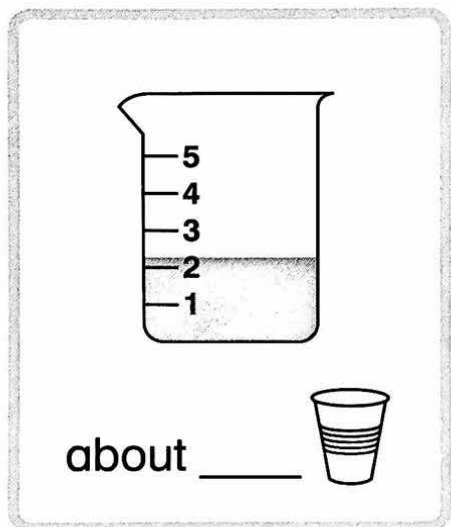

Thermometers

We use a **thermometer** to tell how **hot** or **cold** something is.

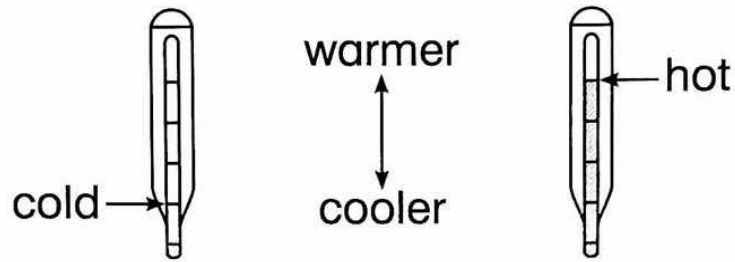

Circle the glass with **warmer** water.

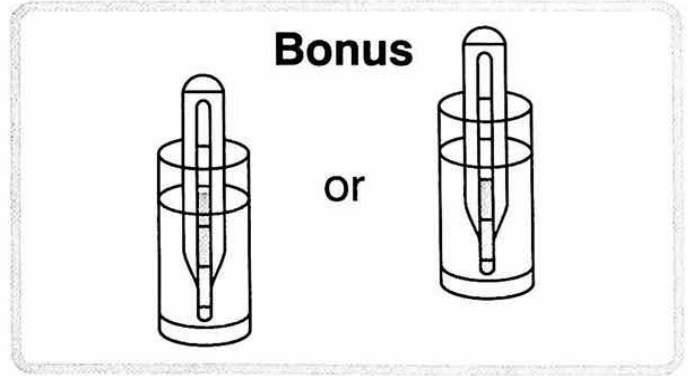
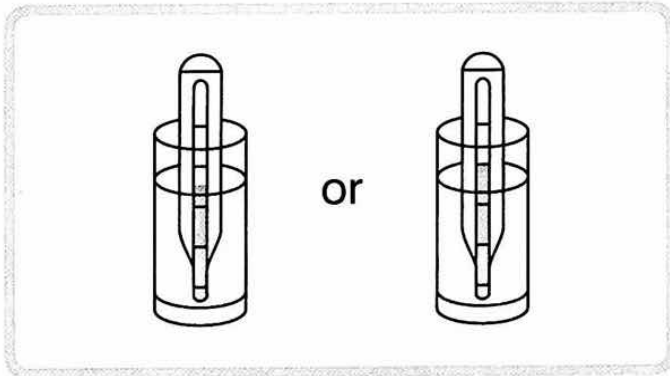
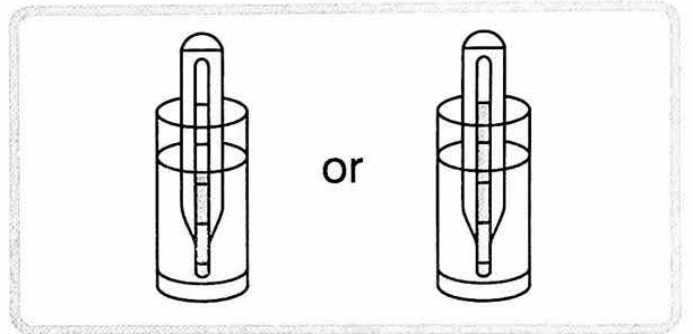
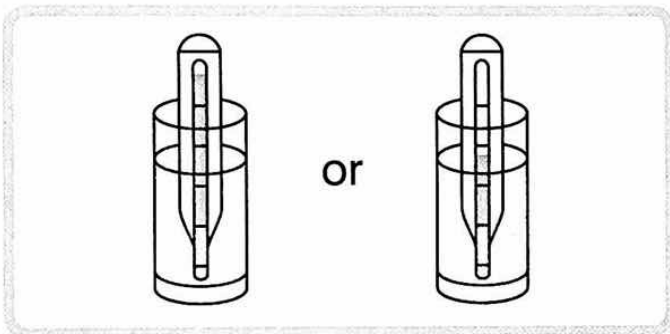

As we heat water, it gets warmer.

What happens 1st, 2nd, and 3rd?

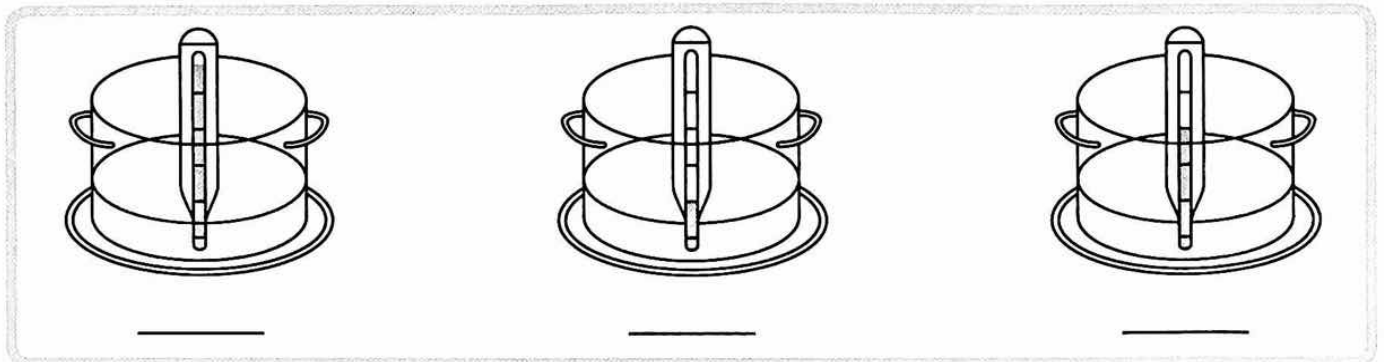

Measuring Area

Use big  as a unit.

Measure the area.

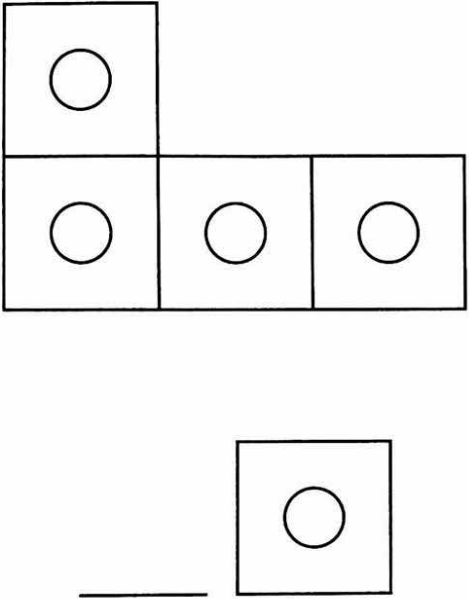

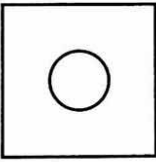
_____ 

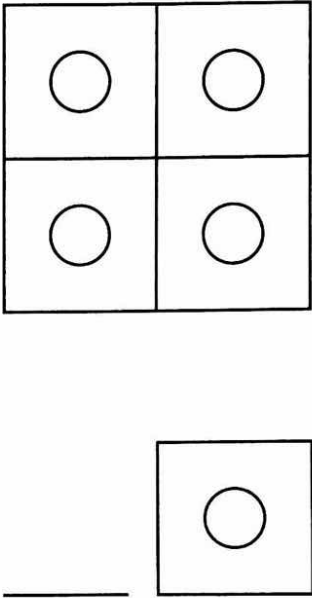

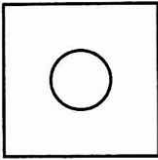
_____ 

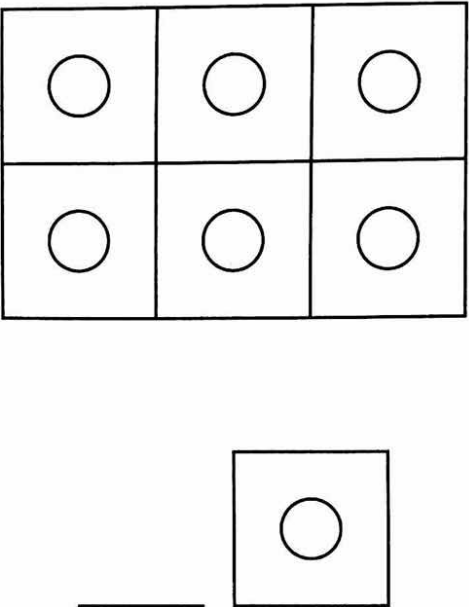

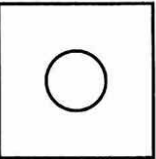
_____ 

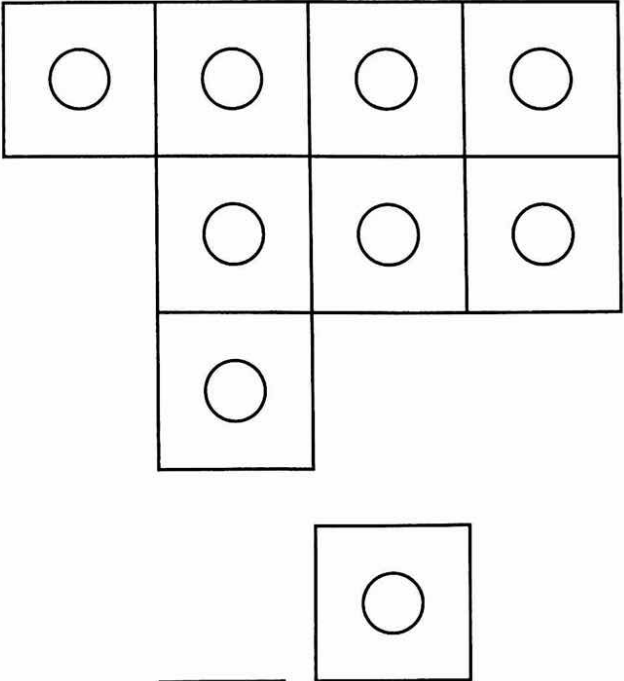

_____ 